

Article number: 2310305481ESD

Description: E+G Antistatic base for levelling elements
LV.A-100-14-M16x68-ESD-C

Measures

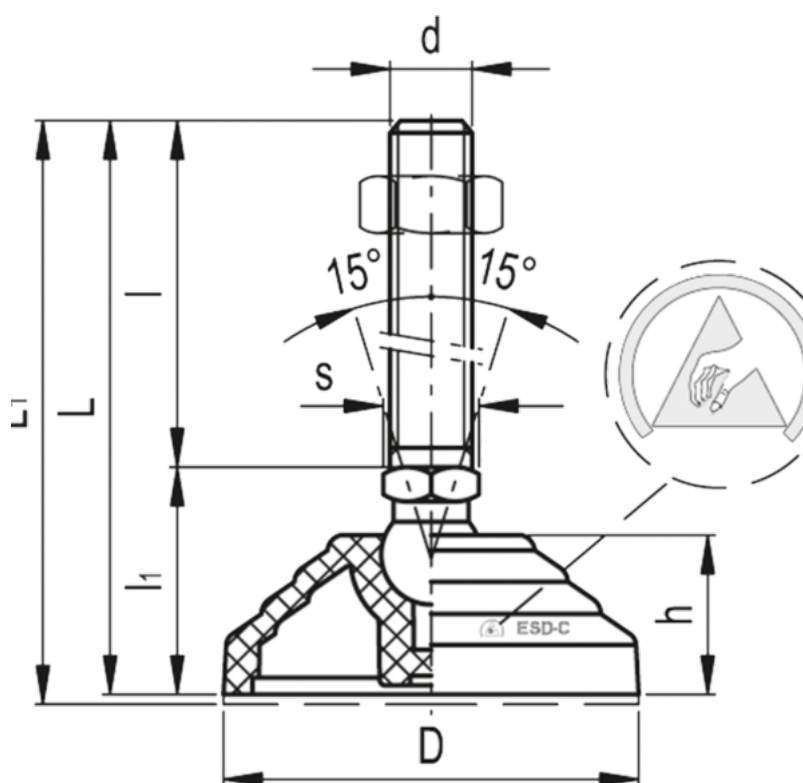

Articulation = 14
D = 100
d = M16
h = 24
l = -
l1 = -
L = 101
Max load = 18000

s = 16
Weight in (g) = 171